

BLINK SOLAR

Battery solar container energy storage system in Kuala-Lumpur



Overview

Where in Malaysia is solar battery storage available?

GSL ENERGY has completed many more solar battery storage installations across Malaysia, including for homes, telecom towers, agricultural businesses, and factories in Penang, Selangor, Johor, Sabah, and Sarawak. GSL ENERGY offers cost-effective solar battery bank solutions with international certifications including CE, IEC62619, UN38.3, and more.

Why is solar battery storage important in Malaysia?

Whether for residential or commercial use, solar battery storage addresses Malaysia's three key energy challenges: Grid Instability in East Malaysia
Frequent outages in Sabah, Sarawak, and rural villages impact households, schools, and medical clinics. Peak Electricity Costs in Peninsular Malaysia.

What is a battery energy storage system (BESS) in Malaysia?

1. Ditrolic Energy Ditrolic Energy is at the vanguard of Malaysia's transition to sustainable energy, offering versatile Battery Energy Storage System (BESS) solutions. These systems are not just stand-alone; they can be integrated with solar, wind, or microgrid setups, underpinning a future-proof energy strategy.

What is a solar panel & battery system?

Solar + Solar panel + battery = uninterrupted power supply during outages.
Residential Energy Storage Solutions System Sizes: 5kWh, 10kWh, 15kWh wall-mounted solar batteries
Ideal For: Villas, landed houses, condominiums
Inverter Brands: Deye, Growatt, GoodWe, Solis

Battery solar container energy storage system in Kuala-Lumpur







Energy Storage Company Malaysia , Ditolic

Battery Energy Storage System Save up power for your future needs We help you store your energy until it's needed. Our battery energy storage system solutions are available as a stand ...

High Quality , Solar Battery System Supplier Malaysia

Solar Battery System Supplier Malaysia is to enhance your energy storage solutions for optimal efficiency. Contact us today for further information!

 **TAX FREE**    

Product Model
HJ-ESS-215A(100KW/215KWh)
HJ-ESS-115A(50KW 115KWh)

Dimensions
1600*1280*2200mm
1600*1200*2000mm

Rated Battery Capacity
215KWH/115KWH

Battery Cooling Method
Air Cooled/Liquid Cooled



Solar Battery Energy Storage System (BESS) in ...

Plus Xnergy deliver green energy solutions with alternative green power resources for solar panels. As a leading solar company in Malaysia, we ...

Solar Storage For Sale In Malaysia , Solar ...

Browse to find the AlphaESS Residential System fit for your specific at-home or residential purpose. Considered a leader in the energy service ...



High Quality , Solar Battery System Supplier ...

Solar Battery System Supplier Malaysia is to enhance your energy storage solutions for optimal efficiency. Contact us today for further information!

Competitive Bidding for Battery Energy ...

The Ministry of Energy Transition and Water Transformation (PETRA), through the Energy Commission (EC), has launched an open ...

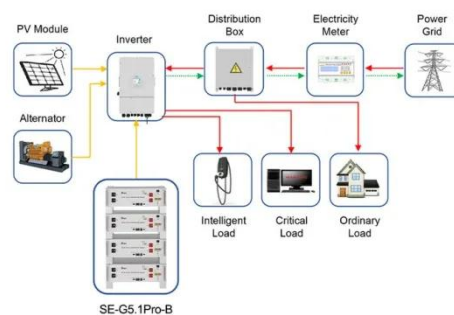

Application scenarios of energy storage battery products

Leader Energy and Plus Xnergy to Deploy Malaysia's First NaS Battery

Kuala Lumpur, Thursday, 10 October

2024 - Leader Energy Group Berhad ("Leader Energy") via its wholly-owned subsidiary Leader Solar Energy II Sdn Bhd ("LSE II") ...



Malaysia's 4 GW / 5.12 GWh solar-plus-storage complex gets ...

Industry Malaysia's 4 GW / 5.12 GWh solar-plus-storage complex gets World Bank funding The Southern Johor Renewable Energy Corridor (SJREC) will be developed as part of ...



SOLAR ENERGY STORAGE FUTURE MALAYSIA 2025 KUALA LUMPUR

Containerized System Innovations & Cost Benefits Technological advancements are dramatically improving solar storage container performance while reducing costs. Next-generation thermal ...

Top 5 Battery Energy Storage System ...

As Malaysia strides towards an eco-conscious future, the integration of

Battery Energy Storage Systems (BESS) stands at the ...



Leader Energy and Plus Xnergy to Deploy ...

Kuala Lumpur, Thursday, 10 October 2024 - Leader Energy Group Berhad ("Leader Energy") via its wholly-owned subsidiary Leader ...

Energy storage container, BESS container

Bluesun provides 500 kwh to 2 mwh energy storage container solutions. Power up your business with reliable energy solutions.



Malaysia Solar Battery Storage Solutions for ...

Discover Malaysia's solar battery storage opportunities for homes and businesses.

Learn about residential battery backup,
...



Battery Energy Storage System (BESS): A ...

Battery energy storage systems (BESS) are revolutionising the green energy industry with their potential to harness and utilise renewable energy ...

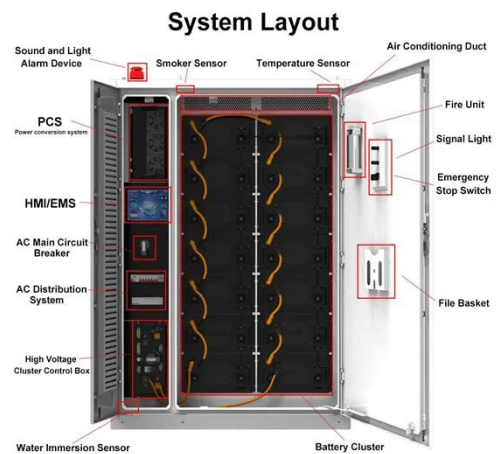

MNA Energy Sdn Bhd

Formed in 2016, MNA ENERGY SDN BHD at the core is a team of innovative technologists, resourceful engineers and visionary ...

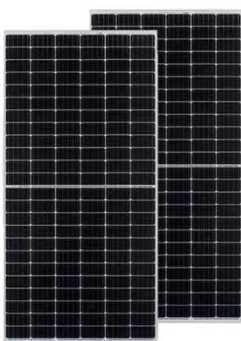

Solar Battery Energy Storage System (BESS) in Malaysia

Plus Xnergy deliver green energy solutions with alternative green power

resources for solar panels. As a leading solar company in Malaysia, we provide cleaner energy solar system & ...



MNA Energy Sdn Bhd

Formed in 2016, MNA ENERGY SDN BHD at the core is a team of innovative technologists, resourceful engineers and visionary entrepreneurs driven by a passion for ...

Malaysia Solar Battery Storage Solutions for Homes & Industry

Discover Malaysia's solar battery storage opportunities for homes and businesses. Learn about residential battery backup, commercial BESS systems, and real GSL ENERGY ...



Top 5 Battery Energy Storage System Companies in Malaysia

As Malaysia strides towards an eco-conscious future, the integration of

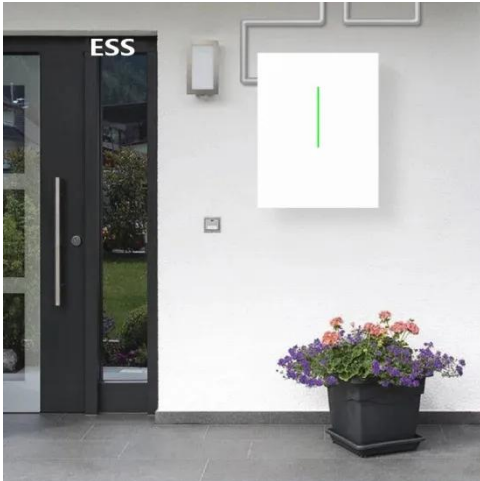

Battery Energy Storage Systems (BESS) stands at the forefront of this transformative journey.

Energy storage container, BESS container

Energy Storage Container Adding Containerized Battery Energy Storage System (BESS) to solar, wind, EV charger, and other renewable ...



The Ultimate Guide to Battery Energy Storage ...

Maximize your energy potential with advanced battery energy storage systems. Elevate operational efficiency, reduce expenses, and ...

Battery Energy Storage System BESS

QH Tech is a high-technical company specializing in the research, production,

and selling of LiFePO4 batteries and multi-scenario ...



Our Lifepo4 batteries can be connected in parallel and in series for larger capacity and voltage.



Sungrow to supply 100MW/400MWh battery ...

A signing ceremony was held at Sungrow's Malaysia HQ. Image: Sungrow
Sungrow has agreed to supply battery energy storage ...

KUALA LUMPUR NEW ENERGY DIGS DEEP INTO ENERGY STORAGE BATTERIES

Containerized System Innovations & Cost Benefits Technological advancements are dramatically improving solar storage container performance while reducing costs. Next-generation thermal ...

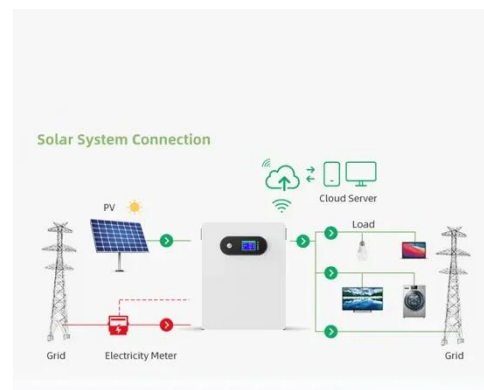

CATL EnerC+ 306 4MWH Battery Energy ...

The EnerC+ container is a modular integrated product with rechargeable



lithium-ion batteries. It offers high energy density, long ...

Containerized Battery Energy Storage Systems (BESS)

Our's Containerized Battery Energy Storage Systems (BESS) offer a streamlined, modular approach to energy storage. Packaged in ISO-certified containers, our Containerized BESS ...

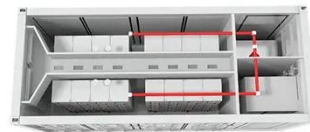

Energy Storage Company Malaysia , Ditrolic

Battery Energy Storage System Save up power for your future needs We help you store your energy until it's needed. Our battery energy storage ...

Contact Us

For catalog requests, pricing, or partnerships, please contact:

BLINK SOLAR

Phone: +48-22-555-9876

Email: info@blinkartdesign.pl

Website: <https://www.blinkartdesign.pl>

Scan QR code to visit our website:

